Instruction Manual

Rogowski Coil Current Probe

SS-281A(-H)/282A(-H)

SS-283A(-H)/284A(-H)

SS-285A(-H)/286A(-H)

SS-287A(-H)/288A(-H)

SS-289A(-H)

IWATSU

Contents

Preface	1
Important Safety Precautions	1
WARNING	2
CAUTION	5
Verify packed Items.....	7
Components.....	7
Management of instrument	8
Repair and sending instrument to be repaired.....	8
Cleaning of this instrument	8
Chapter 1 Overview	9
1.1 Rogowski Coil Current Probe	9
1.2 Features.....	10
1.3 Usage Example	11
Chapter 2 Names and Functions	12
2.1 Main Unit.....	12
2.2 Names and Functions of Main Unit.....	13
2.3 Rogowski Coil Sensor	14
Chapter 3 Measurement Principle.....	15
3.1 Rogowski Coil Sensor	16
3.2 Main Unit.....	17
Chapter 4 Measurement	18
4.1 Preparation for Measurement.....	18
4.2 Measurement Procedure.....	19
4.3 Before Measurement	22
Chapter 5 Specifications	25
5.1 Specifications	25
5.2 Appearance	27

Contacts

Memo



Preface

- ◇ Thank you for purchasing the Rogowski Coil Current Probe SS-280A(-H) Series. We sincerely hope to continue using our instruments for a long time.
- ◇ We ask you to thoroughly read this manual before commencing operation and to keep it at a readily accessible location for future reference.

Important Safety Precautions

To ensure safe operation of this instrument and to prevent injury to the user or damage to property, read and carefully observe ⚠ WARNING and ⚠ CAUTION in the following sections.

Definition of WARNING and CAUTION as used in this manual

 WARNING	Incorrect operation or failure to observe a warning may result in death or serious injury.
 CAUTION	Incorrect operation or failure to observe a caution may result in bodily injury or damage to the instrument.

Notices

- ◇ Some of the contents of this manual may be modified without notice for improvements in specifications and functions.
- ◇ Reproduction or reprinting of the contents of this manual without prior permission from IWATSU is prohibited.
- ◇ If any question arises about this instrument, contact IWATSU or our sales distributors.

Revision History

- ◇ March 2015: 1st edition
- ◇ June 2015: 2nd edition
- ◇ January 2016: 3rd edition
- ◇ April 2018: 4th edition
- ◇ November 2018: 5th edition
- ◇ December 2018: 6th edition
- ◇ February 2019: 7th edition
- ◇ February 2020: 8th edition
- ◇ October 2020: 9th edition
- ◇ January 2021: 10th edition
- ◇ October 2021: 11st edition

KML094051

Read the following safety information.



WARNING

- **Never use this sensor on uninsulated conductors in CAT II.**
An electric shock or failure may occur.
- **If you notice smoke, foul odor, or abnormal noise, immediately remove this instrument from the target to be measured, power off the equipment connected with this instrument, and then turn the POWER switch to the O side to turn off the power to this instrument (remove the AC adaptor from the outlet when used).**
Continued use under these circumstances may result in an electric shock or fire. Contact IWATSU or our sales distributors for repair. Do not attempt to repair this instrument yourself.
- **Never use this instrument for measurement where current or frequency to be measured exceeds the specifications (refer to the absolute maximum di/dt in Section 5.1 of this manual).**
If the measurement is performed without considering the specifications, an electric shock or failure may occur.
- **Do not use under conditions where the sensor coil generates heat due to induction heating.**
Even if the absolute maximum di/dt is within the range, the coil itself is metal, so induction heating causes the coil itself to generate heat, which may cause smoke, fire, or malfunction.
- **Never use the coil and sensor cable of this instrument's input part for the measurement where voltage exceeds the following value (the voltage is described on the input part of this instrument).**
An electric shock or failure may occur.
 - 1.2 kVpeak (insulated conductors).
- **Use caution not to wet this instrument or allow entry of water or foreign objects into it.**
Continued use under these circumstances may result in an electric shock, fire, or failure. If water, foreign objects, or other substances enter this instrument or the instrument is wet with water, immediately remove this instrument from the target to be measured, power off the equipment connected with this instrument, and turn the POWER switch to the O side to turn off the power to this instrument (or remove the AC adaptor from the outlet). After that, contact IWATSU or our sales distributors for repair.
- **Do not use this instrument with wet hands.**
If not, an electric shock, fire, or failure may occur.

[Read the next page.]

Read the following safety information. (continued)



WARNING

- **Do not modify or disassemble this instrument.**

Modification or disassembly of this instrument could result in an electric shock, fire, or failure. Repair of a modified product may be refused. Contact IWATSU or our sales distributors for repair.
- **Use the accessory size AA alkaline batteries or equivalent for this instrument. Do not use new batteries in combination with old ones.**

Using a battery that does not comply with the above requirements may result in a fire or failure.
For information on the recommended batteries, refer to Notes 1 and 2 of Section 5.1 "Specifications."
- **Use the dedicated optional AC adaptor only.**

If not, a fire or failure may occur.
- **If the AC adapter power cord is damaged, replace it with an appropriate cord that is rated and certified in your country.**

An electric shock or failure may occur.
- **Observe the following when handling the Coil Sensor, Sensor cable, BNC cable or AC adaptor (option) of this instrument.**

If not, an electric shock, fire, or failure may occur. Do not use any of the cables or AC adaptor if damaged. Contact IWATSU or our sales distributors for repair.

 - Do not modify any cable or the AC adaptor cable.
 - Do not pull on any cable or the AC adaptor cable.
 - Do not forcibly bend any cable or the AC adaptor cable.
 - Do not heat any cable or the AC adaptor cable.
 - Do not twist any cable or the AC adaptor cable.
 - Do not wet any cable or the AC adaptor cable.
 - Do not tie any cable in a bundle or the AC adaptor cable.
 - Do not put heavy objects on any cable or the AC adaptor cable.
- **Do not connect the AC adaptor (option) to outlets to which multiple cords are attached.**

Failure to do so may be a cause of a fire or overheating.
- **Securely insert the AC adaptor (option) into the outlet.**

Contacting the plug blade of the AC adaptor with metal may be a cause of an electrical shock or fire.
- **In an emergency, disconnect the AC power cord from the power source.**

If not, a fire or failure may occur.

[Read the next page.]

Read the following safety information. (continued)



WARNING

- **Do not use this instrument in an environment with explosive gases.**

Failure to do so may cause an explosion.
- **Avoid the generation of Corona discharge in an environment where high voltage is applied to the sensor part for a long time.**

Depending on the frequency of the applied voltage and installation conditions of the sensor part, Corona discharge may be generated even when a voltage lower than resisting voltage is applied to the sensor part. This generation may lead to degrading the insulating outer sheath, causing an electrical shock, fire, or failure.
Corona discharge tends to be generated due to electric field concentration. Take some measures to avoid the generation; for example, keep the sensor part away from high-voltage parts as far as possible or achieve insulation.
- **Do not use this instrument in a highly humid environment where condensation may occur.**

If not, an electric shock, fire, or failure may occur.
- **When thunder begins, pull out the power plug of a device or the AC adaptor to which this instrument is connected from the outlet. Then, detach this instrument from the target to be measured, and do not use it.**

Lightning may be a cause of an electric shock, fire, or failure.
- **Do not use this instrument when it has failed.**

Using a failed main unit, cable or AC adaptor may be a cause of an electric shock or fire. In the event of a failure, contact IWATSU or our sales distributors for repair.
- **Turn off the power to the target to be measured before attaching or detaching the Rogowski Coil Sensor part of this instrument to or from the target to be measured.**

Failure to do so is very dangerous for targets to be measured that use high voltage and high current.
- **Be sure to use the free end of the Rogowski Coil while inserted in the joint hall. Do not apply a high voltage exceeding the specifications (refer to Section 5.1 “Specifications”) to the Rogowski Coil Sensor.**

Failure to do so may cause an electric shock, fire, or failure.
- **The sensor cable cannot be removed because it is integral with (connected inside of) the main unit. Do not attempt to disconnect the sensor cable.**

Failure to do so may cause an electric shock, fire, or failure.

[Read the next page.]

Read the following safety information. (continued)



CAUTION

- **Hold the plug when removing the AC adaptor from the outlet.**

Pulling on the AC adaptor cable will damage the cable. This may be a cause of an electric shock, fire, or failure.
- **Do not expose to rapidly-changing temperature, mechanical stress, or impact.**

The main unit, Coil Sensor, BNC cable and AC adaptor will be damaged if exposed to these. This will be a cause of a failure.
- **Do not use or store this instrument in a location with direct sunlight, high temperature, high humidity, or dew condensation. SS-280A series and SS-280A-H series are different in operating temperature range of the Rogowski Coil Sensor.**

Operation or storage outside the specifications could result in deformation, deteriorated insulation, or a failure due to heat. The ranges of operating and storage temperature and humidity are as follows:

 - Operating temperature: Main Unit 0 to +40°C, no dew condensation
Sensor SS-280A : -40°C to $\pm 125^{\circ}\text{C}$, no dew condensation
SS-280A-H: -40°C to $\pm 150^{\circ}\text{C}$, no dew condensation
 - Operating humidity: below the moisture amount of 80%RH
 - Operating altitude: 2000 m or less (at +25°C or less)
 - Storage temperature: -10°C to +60°C, no dew condensation
 - Storage humidity: below the moisture amount of 80%RH
- **Do not place this instrument in a location with excessive humidity or dust.**

If not, an electric shock, fire, or failure may occur.
- **Do not put this instrument in a place exposed to lamp soot or steam generated by counters, humidifiers, etc.**

If not, an electric shock, fire, or failure may occur.
- **Avoid pulling or bending the Rogowski Coil Sensor part with excessive force as much as possible. The Rogowski Coil has a coil structure consisting of an extra-fine wire rod wound tight.**

Pulling or bending the Rogowski Coil Sensor part with excessive force may degrade the specifications of the sensor part due to the change of the coil structure.
- **When adjusting the DC offset voltage (zero point), use the included accessory Adjustment Screwdriver, align the tip of the screwdriver with the adjustment slot, and turn it without applying excessive pressure. The required rotation torque is less than 20 mN·m.**

If using a screwdriver other than the accessories or applying excessive pressure to ZERO ADJ of the main unit while you don't align the included accessory Adjustment Screwdriver with the adjustment slot, you may damage the main unit or the tip of the screwdriver.

[Read the next page.]

Read the following safety information. (continued)



CAUTION

- **For your safety, when this instrument is not used for a long time, turn the POWER switch to the O side to turn off the power to this instrument, and then remove the batteries from this instrument (remove the AC adaptor from the outlet when used).**
- **Keep the AC adaptor (option) away from heaters.**

Failure to do so will melt the sheath of the adaptor cord. This may be a cause of an electrical shock or fire.
- **Before moving this instrument, make sure that the AC adaptor (option) is disconnected from the outlet and that the Coil Sensor, BNC cable, and other external connection lines are removed.**

Failure to do so will damage the AC adaptor cord or cable, causing an electrical shock, fire, or failure.
- **To use this instrument, connect it to the ground (output side).**

Ground GND terminals of monitoring devices, which are the connection destination of the output terminal.
Do not energize a target to be measured with nothing connected to the output terminal. This may be a cause of an electrical shock.
- **Pay attention to the polarity indication (plus and minus signs) when placing batteries in this instrument.**

A reversely placed battery will result in battery explosion or leakage. This may cause a fire, injury, failure, or contamination of the surrounding environment.
- **Do not throw used batteries in the fire.**

Batteries thrown in the fire may explode, causing a fire or burn.
For information on disposing of used batteries, refer to "Management of instrument" on page 8.
- **Before transporting this instrument, remove the batteries, house this instrument in the accessory hard case, and then pack the housed instrument in the packing material used at the time of purchase, or the equivalent or better.**

This instrument may fail if a large vibration or impact is applied during transportation, possibly causing a fire. If you do not have a proper packing or shock-absorbing material for transportation, contact IWATSU or our sales distributors. If transportation is to be handled by a forwarding agent, display "Contains a precision machine" on each side of the packing box.
- **For your safety, remove the batteries (or the AC adaptor (option) from the outlet), monitoring devices, and the target to be measured from this instrument before maintenance. In addition, wipe off with a dry cloth when water droplets are attached.**

If not, an electric shock or failure may occur.
- **We recommend that you contact IWATSU or our sales distributors for periodic inspection and calibration about once a year.**

Verify packed Items

When receiving this instrument, verify the packed items while referring to the following "Components." If there is a missing item or an item damaged during transportation, immediately contact IWATSU or our sales distributors.

Components

- Rogowski Coil Current Probe 1
- Accessories (See the accessories table below.)

Accessories table

Items	Quantities
Hard case	1
BNC cable	1
Adjustment Screwdriver (flat tip)	1
AA dry battery	4
Instruction Manual (this document)	1

- Option
 - AC adaptor
UNIFIVE CO., LTD.
Model No: UNI312-0716
I/P: AC 100-240V 50/60Hz 0.4A

Note: The AC adaptor (option) can be purchased additionally later.
Purchase separately the AC adaptor power cord meets the designated standards of the country and area that you are using it in.

Management of instrument

When disposing of this instrument, it must be recycled or disposed of properly in accordance with local laws or regulations. When disposing of it, request a recycling company to dispose of it in accordance with local laws or regulations.

Repair and sending instrument to be repaired

If a failure occurs, send the instrument to IWATSU or our sales distributors.

When sending an instrument to be repaired, clearly write the instrument name, serial number (in the label on the rear of this instrument), description of the failure, and the name, division, and telephone number of the responsible person.

Cleaning of this instrument

To clean this instrument, wipe it gently with a soft cloth moistened with a small amount of water or mild detergent. Never use solvents such as benzene, alcohol, acetone, ether, ketones, thinners, or gasoline, as they can deform and discolor the case.

Chapter 1 Overview

1.1 Rogowski Coil Current Probe

This instrument is a current probe that uses the Rogowski Coil as a sensor.

The electric current of the place etc. where the terminal and the electric circuit of the semiconductor device are complicated can be measured by using this instrument.

The coil of this instrument detects a change in magnetic flux caused by the current (target to be measured) flowing through the inside of the coil that forms a closed loop. The change in magnetic flux generates an electromotive force in the coil. The electromotive force is proportional to a differential value of the current. The output (electromotive force) of the Rogowski Coil is the differential waveform of the current. To detect the current waveform, the waveform is integrated by the main unit of this instrument (for details, refer to Chapter 3 "Measurement Principle").

This series has nine models, which differ in sensitivity (mV/A), peak current (A), low frequency cutoff (Hz), and other specifications.

Each model has two types, which differ in operating temperature range of the Rogowski Coil Sensor; that is, this series has a lineup of fourteen models.

Connecting the output part of this instrument and an oscilloscope and other monitoring devices with the BNC cable allows observation of the current waveform that flows through a target to be measured.

1.2 Features

The following describes the features of this instrument.

○ **Targets of measurement**

- Semiconductor switch waveforms
- Transient current and pulsed current etc. of electrical instrument

○ **Compact measurement**

The Rogowski Coil that detects the electric current thinly has the following advantages for the removable type (In the length of the coil, it is 84mm, and the diameter in the coil section is 1.7mm or less).

- The measurement in the place where the electric circuit is complicated can be done.
- The terminal of the semiconductor device can be measured.
- It is useful and flexible even in a narrow point.
- Superior heat resistance and insulation property around the coil

○ **This instrument has the following specifications** (for details, refer to Section 5.1 “Specifications”).

- Frequency bandwidth: f_L to 30 MHz [-3 dB]
(f_L : Low-Frequency cutoff)
- Peak current: 30 A to 12000 A
(Seven models of 30 A, 60 A, 120 A, 300 A, 600 A, 1200 A , 3000 A , 6000 A and 12000 A)
- Sensitivity accuracy: $\pm 2\%$ (at the center of the coil loop)
- Linearity: $\pm 0.05\%$ of full scale

○ **Power supply**

- This instrument operates with the supplied alkaline batteries or equivalent four AA dry batteries. It also operates with the AC adaptor (option).

Note: The power supply of this instrument is the AC adaptor when batteries and the adaptor are used in combination. It is changed from batteries to the adaptor by inserting the adaptor plug into the outlet. For this reason, during operation with batteries, this instrument may be stopped temporarily when the adaptor plug is inserted into the outlet.

1.3 Usage Example

To measure current using this current probe, place a conductor to be measured through the coil loop, and detect a change in magnetic flux caused by the current flowing through the conductor with the Rogowski Coil as an electromotive force, as shown in the following usage example (conceptual illustration). The electromotive force (differential value of the current) passes through the input part of the main unit, and it is integrated by the integrator of the main unit.

The integrated current value is converted to voltage with a sensitivity (mV/A) set for each main unit. The converted voltage is output from the output terminal of the main unit. Inputting the output voltage to an oscilloscope and other monitoring devices allows observation of the current waveform.

The sensor cable cannot be removed, because it is integral with (connected inside of) the main unit. Connect the main unit and monitoring devices with the BNC cable.

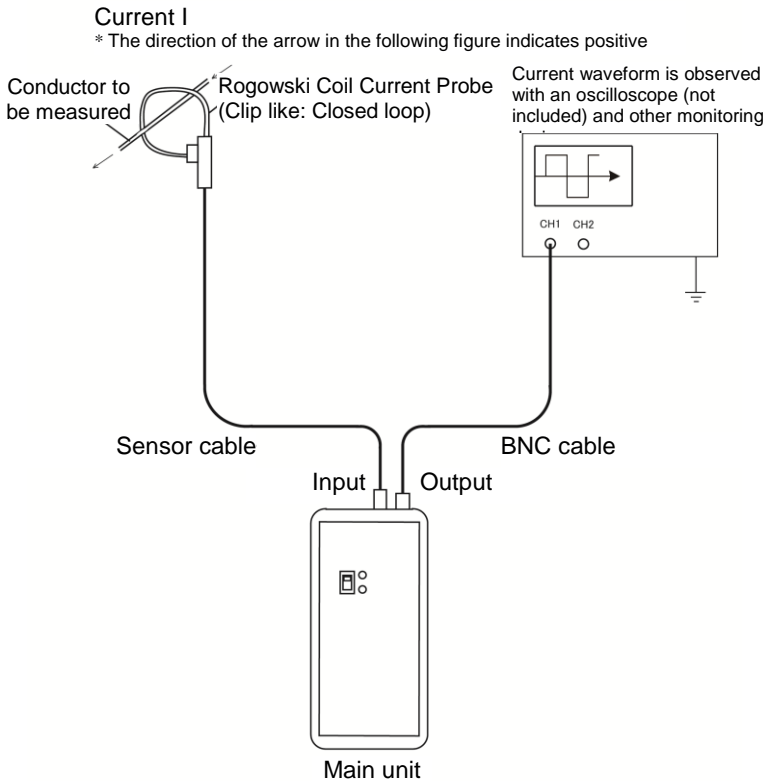
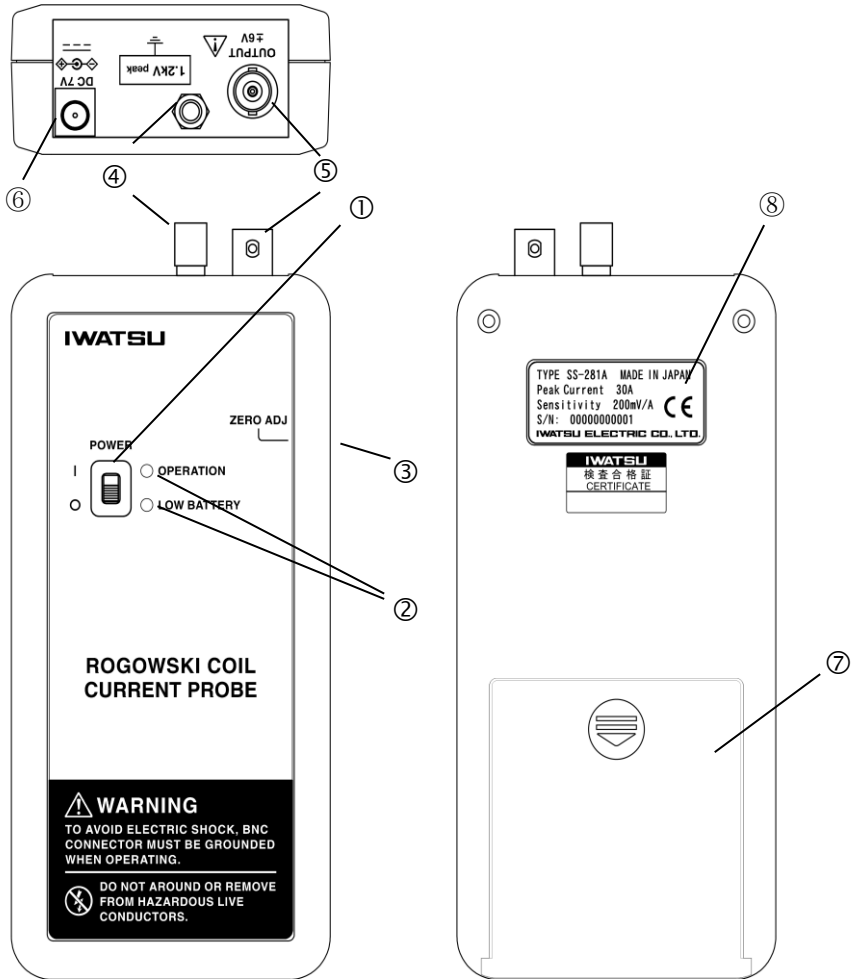

Figure 1.1 Usage Example of This Current Probe (Conceptual Illustration)

Chapter 2 Names and Functions

2.1 Main Unit





2.2 Names and Functions of Main Unit

No.	Name	Description	Reference
①	POWER switch	Turns this instrument on and off. This instrument is turned on when this slide switch is moved to the I side and is turned off when moved to the O side. This instrument operates with four AA dry batteries placed in its back (battery case [Ⓞ]).	▶ Section 4.2
②	LED lamps OPERATION LOW BATTERY	Indicates the operating condition of the power supply of this instrument. Comes on green when this instrument is turned on and comes off when turned off. Indicates the state of AA dry batteries. This lamp turns yellow when the batteries are consumed. Replace them when the lamp lights up yellow.	
③	ZERO ADJ	Used to adjust the ZERO point of the output ^⑤ . There is a hole for ZERO point adjustment on the side of ZERO ADJ. Insert the accessory Adjustment Screwdriver into the hole to perform ZERO point adjustment.	▶ Section 4.2
④	Input part	The sensor cable (refer to Section 2.3) integral with the main unit is connected to this part.	▶ Section 2.1
⑤	Output part	BNC output connector. Outputs the voltage (current waveform) of the main unit.	▶ Section 2.1
⑥	Connector for AC adaptor (input)	Used to connect the AC adaptor (option) for this instrument to this connector. The adaptor supplies power by converting commercial power supplies to 7 VDC. This instrument operates with the AC adaptor (option) when the adaptor is connected to this connector.	▶ Section 2.1
⑦	Battery case	Located on the back of the main unit and used to house four AA dry batteries. To open this battery case, push its lid downward. Place the batteries in this case while paying attention to their orientation, and then close the lid.	▶ Section 2.1
⑧	Back label	There is a label placed on the back of the main unit. The label describes the following: <ul style="list-style-type: none"> • TYPE: One of the eighteen models, SS-281A(-H)~SS-289A(-H) • Peak Current: One of the current values that the above model handles, 30A, 60A, 120A, 300A, 600A, 1200A, 3000A, 6000A, 12000A. • Sensitivity: Voltage sensitivity (mV/A) of the current that the above model handles. • S/N: 11-digit serial number 	▶ Section 2.1

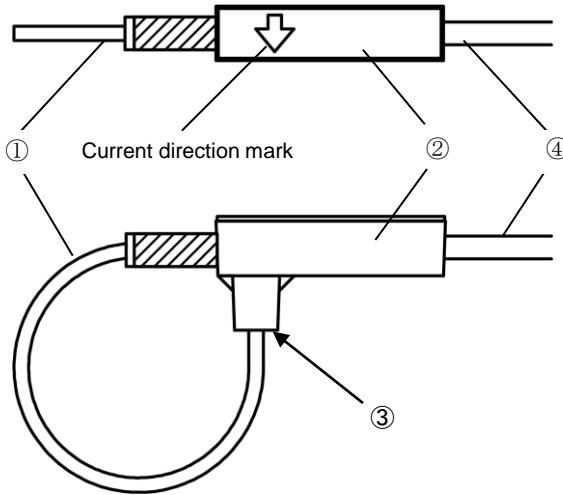
2.3 Rogowski Coil Sensor



No.	Name	Description
①	Rogowski Coil	A coil for detecting the current in conductors to be measured. Forms a closed loop during measurement. Covered with an insulating outer sheath for heat resistance and insulation.  is Black : SS-280A Series  is Gray : SS-280A-H Series (*) Note: This may discolor depending on the measurement environment. It does not affect the specifications of the instrument.
②	Joint box	The sensor cable ④ is secured to one end so that the Rogowski Coil forms a closed loop. There is a joint hole ③ to secure the other end of the coil.
③	Joint hole	A part of the joint box ② and has a hole to insert the Rogowski Coil. The one end of the coil ① can be removed from this hole by hand.
④	Sensor cable	A coaxial cable used to input the electromotive force (differential value of the current) that is generated in the Rogowski Coil to the main unit.

Chapter 3 Measurement Principle

This instrument is designed to measure the current (current waveform) in conductors to be measured.

It consists of the Rogowski Coil Sensor and the main unit (integrator). Sections 3.1 and 3.2 in this chapter describe measurement principles and functions of each part and are concluded with an explanation of a process of measuring the current (current waveform).

3.1 Rogowski Coil Sensor

Figure 3.1 shows that the current I flows through the conductor to be measured. This section describes the principle of detecting this current by the Rogowski Coil step by step.

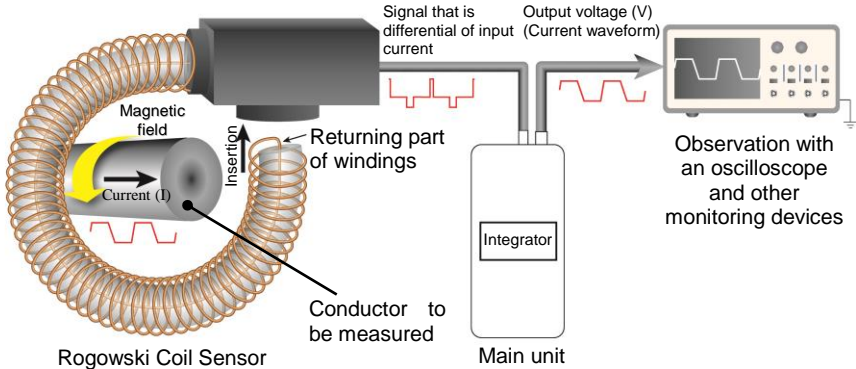

Note) The above figure is a conceptual illustration to explain this measurement principle. The Rogowski Coil Sensor is actually covered with the insulating outer sheath. During measurement, one end of the Rogowski Coil is inserted into the joint hole on the joint box.

Figure 3.1 Conceptual Illustration of Rogowski Coil

It is assumed that the conductor to be measured is placed inside of the loop of the Rogowski Coil. A magnetic field is generated around the conductor to be measured. It moves around the conductor in a clockwise direction in relation to the current direction (Ampere's right-handed screw rule).

The magnetic field changes with time, because alternating current flows in the conductor to be measured. In the Rogowski Coil, magnetic flux changes along the loop. When it changes, an electromotive force is generated and current flows in the coil by electromagnetic induction.

Provided that the entire length of the wound Rogowski Coil is l , small radius of the coil turn is r , turn of the coil is N , and current flowing through the coil is i , the electromotive force generated in the coil is expressed by Equation 3.1:

$$e = \frac{\pi r^2 \mu_0 N}{l} \frac{di}{dt} \quad [\text{V}] \quad \dots (3.1)$$

$$\text{Where, } \mu_0 = 4\pi \times 10^{-7} \quad [\text{H/m}]$$

(Permeability of Vacuum)

As shown in Equation 3.1, the electromotive force induced in the coil is determined by the shape and turn of the coil and time differentiation of the current. Thus, the electromotive force must be integrated to determine the current.

3.2 Main Unit

As illustrated in Figure 3.2, the electromotive force e induced in Section 3.1 is brought in the input part of the main unit through the sensor cable.

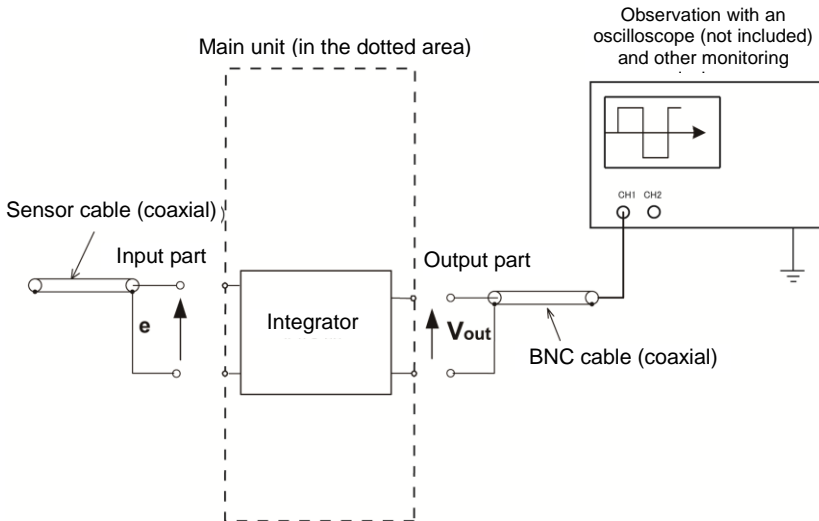

Figure 3.2 Illustration of Rogowski Coil Current Probe Operation

As explained in Equation 3.1 in Section 3.1, the electromotive force e is integrated by the integrator of the main unit, because it is the time differentiation of the current.

The output voltage of the main unit V_{out} is expressed by Equation 3.2.

$$V_{out} = A \int e \, dt \quad \dots\dots (3.2)$$

A: Constant determined by the component constants of the circuit of the main unit

The output voltage of the main unit (current waveform) is observed by an oscilloscope and other monitoring devices through the BNC cable.

As expressed by the following Equation 3.3, the voltage component V_{out} observed by monitoring devices can be converted to the current I with a sensitivity S (mV/A) described on the label affixed to the back of the main unit.

$$I = V_{out} / S \quad \dots\dots (3.3)$$

The current I (current waveform) of the conductor to be measured is determined by the measurement principle described in this chapter.

Chapter 4 Measurement

4.1 Preparation for Measurement

- (1) Have this instrument, a monitoring device, and a target to be measured ready.
 - * A monitoring device means an oscilloscope, DVM, recorder, and other devices.

- (2) Place four AA dry batteries in the main unit, or connect the AC adaptor (option) to this instrument.
 - * The power supply of this instrument is the AC adaptor when the batteries and the adaptor are used in combination.

<For batteries>

- a) To open the case, push downward on the lid of the battery case on the back of the main unit (refer to ⑥ in the appearance in Section 2.1).
- b) Place four AA dry batteries in the battery case.
Note) Do not place them in the wrong orientation.
- c) Close the lid of the battery case.

<For the AC adaptor (option)>

- a) Connect the AC adaptor cable to the connector on the top of the main unit (refer to ⑥ in the appearance in Section 2.1).
- b) Plug the power cord of the AC adaptor into an outlet of a commercial power supply.

- (3) Connect the accessory BNC cable to this instrument.
 - a) Connect one end of the BNC cable to the output part on the top of this instrument (refer to ⑤ in the appearance in Section 2.1).
 - b) Attach the other end of the BNC cable to the monitoring device.



CAUTION

- **To use this instrument, connect it to the ground (output side).**

Ground GND terminals of monitoring devices, which are the connection destination of the output terminal. Do not energize a target to be measured with nothing connected to the output terminal. This may be a cause of an electrical shock.

4.2 Measurement Procedure

- (1) Make sure that all preparations described in the previous section are completed.
- (2) Set up a target to be measured so that it can be used.

Do not energize the target to be measured even when it is ready to be used.

! WARNING

Do not energize a target to be measured before attaching the Rogowski Coil of this instrument to the target. It is dangerous to apply power to the target to be measured before the attachment.

- (3) Place the target to be measured through the Rogowski Coil Sensor.
 - a) As illustrated in Figure 4.1, release free end of Rogowski Coil from the joint hole.

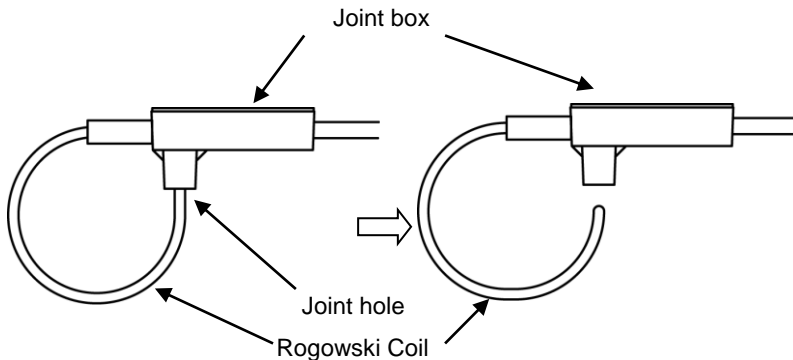

Figure 4.1 How to connect Rogowski Coil

- b) Loop the Rogowski Coil around the conductor to be measured.
- c) Insert the Rogowski Coil into the joint hole.
 - *: The insertion length of the coil is about 8 mm from the joint hole end. Insert the coil until bumping. To achieve accurate measurement, be sure to insert the end of the coil into the joint hole securely.

The current detection polarity is shown as in the following figure. Positive polarity is output by current flowing in the direction indicated by the current direction mark shown on the joint box.

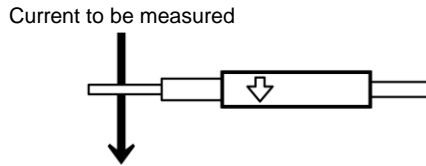
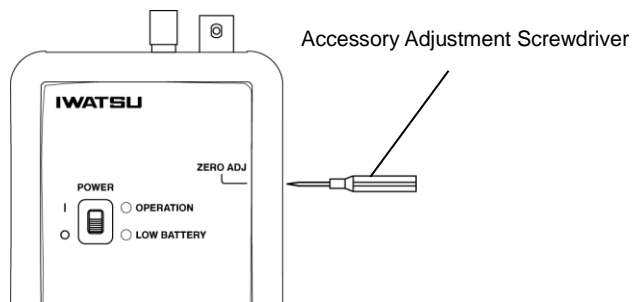

Figure 4.2 Current Detection Polarity

- (4) Turn on this instrument (this instrument is turned on by turning the slide switch shown in the following figure to the I side and off by moving the switch to the O side).



- (5) Adjust the ZERO point of the output observed by monitoring devices.
- Have the included accessory Adjustment Screwdriver ready.
 - As shown in the figure below, there is a hole for ZERO point adjustment on the side of ZERO ADJ on the main unit panel. Insert the screwdriver into the hole and align the tip of the screwdriver with the adjustment slot.



- Turn the screwdriver while watching the monitoring device to perform ZERO point adjustment.

 **CAUTION**

- **When adjusting the DC offset voltage (zero point), use the included accessory Adjustment Screwdriver, align the tip of the screwdriver with the adjustment slot, and turn it without applying excessive pressure. The required rotation torque is less than 20 mN·m.**

If using a screwdriver other than the accessories or applying excessive pressure to ZERO ADJ of the main unit while you don't align the included accessory Adjustment Screwdriver with the adjustment slot, you may damage the main unit or the tip of the screwdriver.

- (6) Energize the target to be measured, and then observe and measure the output with the monitoring device.

4.3 Before Measurement

This section describes notes on accuracy and the handling of the Rogowski Coil Sensor when measuring the current using this instrument.

4.3.1 To Achieve Accurate Measurement

As explained in Chapter 3 “Measurement Principle,” the Rogowski Coil is a wire rod wound tight around a tube-like wick material, as illustrated in Figure 3.1. The coil formed into a ring body detects a change in magnetic flux caused by the current passing through the inside of the coil. The evenly wound coil causes no error even when the current to be measured does not flow through the center of the coil. In addition, each turn of coil enables the cancellation of external magnetic fields.

However, it doesn't become constructional and a complete ring compound because there is a connecting part in the Rogowski Coil.

For reference, Figure 4.3 shows the position of the connection part of the Rogowski Coil.

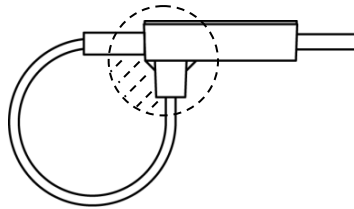

Figure 4.3 Rogowski Coil Connection Part

The connection part of the Rogowski Coil is in the center of the dotted circle. It is known that a larger measurement error is caused as the current to be measured comes closer to this part because the variation of the magnetic flux that cannot be detected increases. Avoid measuring current in the dotted area, because a measurement error of -4% or more may be caused by the measurement performed in the area. In addition, there is a possibility that the measurement error grows because of an external magnetic flux that similarly hangs to the connecting part. Before measuring current, place conductors in which current flows other than the conductor to be measured away from the Rogowski Coil connection part as much as possible.

4.3.2 To Minimize Influence of Fluctuations in Voltage

If there is a part whose voltage fluctuates around the Rogowski Coil Sensor, electrostatic coupling between the part and the Rogowski Coil will occur. This may influence the output from this instrument.

If possible, place the Rogowski Coil Sensor away from the part whose voltage fluctuates. This will improve noise caused by electrostatic coupling. For instance, it is improved to measure the electric current that flows to IGBT in the emitter terminal connected with not the collector terminal that changes greatly the voltage but a constant voltage and is improved the capacitive coupling noise.

4.3.3 Use caution to heat generated by induction heating

In a strong magnetic field due to high frequency and large current, the metal may generate heat due to induction heating. (Applicating: this is IH's electromagnetic cooker)

Since the Rogowski coil has a coiled structure in which a copper wire is wound around a core material, the coil itself, which is a metal, may generate heat by the same principle.

The Rogowski coil can not be used even within the absolute maximum di/dt under conditions such that the coil itself generates heat due to induction heating.



- **Do not use under conditions where the sensor coil generates heat due to induction heating.**

Even if the absolute maximum di/dt is within the range, the coil itself is metal, so induction heating causes the coil itself to generate heat, which may cause smoke, fire, or malfunction.

<Example in which there is a possibility of heat generation by induction heating>

- Drive current of electromagnetic cooker etc.
- Driving current of welding machines, quenching devices, etc. using induction heating
- High frequency power supply output used for semiconductor manufacturing equipment, high frequency drive current

4.3.4 Handling of Rogowski Coil Sensor

The Rogowski Coil has a coil structure consisting of an extra-fine wire rod wound tight around a wick material of Teflon tube. Avoid pulling or bending the Rogowski Coil Sensor excessively as much as possible. The minimum curvature radius of the coil is 5 mm. Application of excessive force to the Rogowski Coil may cause plastic deformation of part of the coil. Use caution when attaching and detaching the coil from a target to be measured. Deformation of the coil structure will degrade the specifications of the sensor. In order to measure current, the one end of the Rogowski Coil is required to be inserted into the joint hole so that the coil forms a loop that circles around the current to be measured. The insertion length of the coil is about 8 mm from the joint hole end. Insert the Rogowski Coil until bumping.

 **WARNING**

- **Avoid the generation of corona discharge in an environment where high voltage is applied to the sensor for a long time.**

Depending on the frequency of the applied voltage and installation conditions of the sensor, Corona discharge may be generated even when a voltage lower than the resisting voltage is applied to the sensor. This generation may lead to degrading the insulating outer sheath, causing an electrical shock, fire, or failure.

Corona discharge tends to be generated due to electric field concentration. Take some measures to avoid the generation; for example, keep the sensor away from high-voltage parts as far as possible to achieve insulation.

 **CAUTION**

- **Stop using the Rogowski Coil with its sheath damaged, because the resisting voltage for insulation of the coil cannot be guaranteed.**
-

The Rogowski Coil has a structural life. The duration of use of the coil depends on the use environment and use conditions.

We recommend that you replace a deformed coil or a coil with its surface damaged, in order to maintain safety and accurate measurement. Contact Iwatsu office or our sales distributors for replacement.

Chapter 5 Specifications

5.1 Specifications

Basic specifications

	SS-281A (-H)	SS-282A (-H)	SS-283A (-H)	SS-284A (-H)	SS-285A (-H)	SS-286A (-H)	SS-287A (-H)	SS-288A (-H)	SS-289A (-H)
Sensitivity [mV/A]	200	100	50	20	10	5	2	1	0.5
Peak current [A]	30	60	120	300	600	1.2 k	3.0 k	6.0 k	12 k
Peak di/dt [kA/μs]	2	4	8	20	40	SS-280A:80 SS-280A-H:40			
Absolute maximum di/dt									
Peak [kA/μs]	80	80	80	80	80	SS-280A:80 SS-280A-H:40			
RMS [kA/μs]	1	1	1.5	1.5	1.5	2	2	2	2
Frequency bandwidth	f _L to 30MHz [-3dB], f _L : Low frequency cutoff								
Low frequency cutoff [Hz]	110	65	32	9	6	3	2	2	2
Noise [mV rms]	3.5	2.5	2.0	1.8	1.8	1.8	1.4	1.4	1.4
Sensitivity accuracy	±2% At the center of the coil loop with sensor part temperature of -10°C to +70°C * Add an error of ±250 ppm/°C when the temperature is -10°C or less or +70°C or more.								
Output	Maximum voltage range: ±6 V (load ≥ 100 kΩ) * Output becomes ±2V and sensitivity becomes about the half for 50Ω load.								
Connector	BNC								
Linearity	±0.05 % of full scale								
Zero point adjustment range	±300 mV or more								

Sensor

Coil length 84 mm ± 4 mm

Wire rod diameter at coil part 1.7 mm (Max)

Maximum rating voltage between ground 1.2 kV peak
Sensor providing basic insulation for max. working voltage of 1200 Vpk and max. transient overvoltages of 2500 Vpk as well as reinforced insulation for max. working voltage of 1200 Vpk and max. transient overvoltages of 1500 Vpk.

Sensor cable length 1.5 m ± 50 mm

Operating temperature and humidity range SS-280A: -40 °C to +125 °C, below the moisture amount of 80 %RH, no dew condensation (including sensor cable)
SS-280A-H: -40 °C to +150 °C, below the moisture amount of 80 %RH, no dew condensation (including sensor cable)

General specification

Dimensions	Approx. 80 (W) × 165 (H) × 35 (D) mm(excluding protrusions)
Weight	Approx.0.37 kg
Power supply	Four AA dry batteries ^{Note 1} or dedicated AC adaptor (option)
Battery runtime ^{Note2}	Approx. 18 hours (when alkaline batteries are used)
Accessories	BNC cable (1) ^{Note3} , Adjustment Screwdriver (1), AA dry battery (4), Instruction Manual (1), and hard case (1)

Environmental characteristics

Operating temperature and humidity range	0 °C to +40 °C, below the moisture amount of 80 %RH, no dew condensation
Storage temperature and humidity range	-10 °C to +60 °C, below the moisture amount of 80 %RH, no dew condensation
Operating altitude	≤2,000 m at ≤+25 °C

Note 1) Equivalent nickel metal-hydride, nickel-cadmium battery, and other rechargeable batteries can also be used.

Note 2) Operation time of this instrument during the use of batteries
The continuous operation time of this instrument is about 18 hours when alkaline batteries are used. The LOW BATTERY LED lamp lights up when batteries are consumed. About 30 minutes after the illumination, this instrument will be automatically shut down to avoid over discharge. Note that from the time the LOW BATTERY LED lamp comes on until the time this instrument is automatically shut down may be shortened when nickel metal-hydride batteries are used.
When using with the accessory batteries, the operation time of this instrument may be shorter than that described above.

Note 3) BNC cable length is recommended 50cm.

Compliance information

This instrument is an IEC safety class I instrument (provided with a terminal for protective earth grounding).

Safety Standard

Compliant standards EN 61010-1:2010 (Third Edition)
Pollution degree 2

EMC Standard

Compliant standards EN 61326-1:2013 (Class A)
This instrument is a Class A (for industrial environments) instrument.
Compliant standards EN 61326-1:2013 (Industrial Electromagnetic Environment)

Environmental standard

Compliant standard: EN IEC 63000:2018 Monitoring and instruments

5.2 Appearance

(1) Main Unit

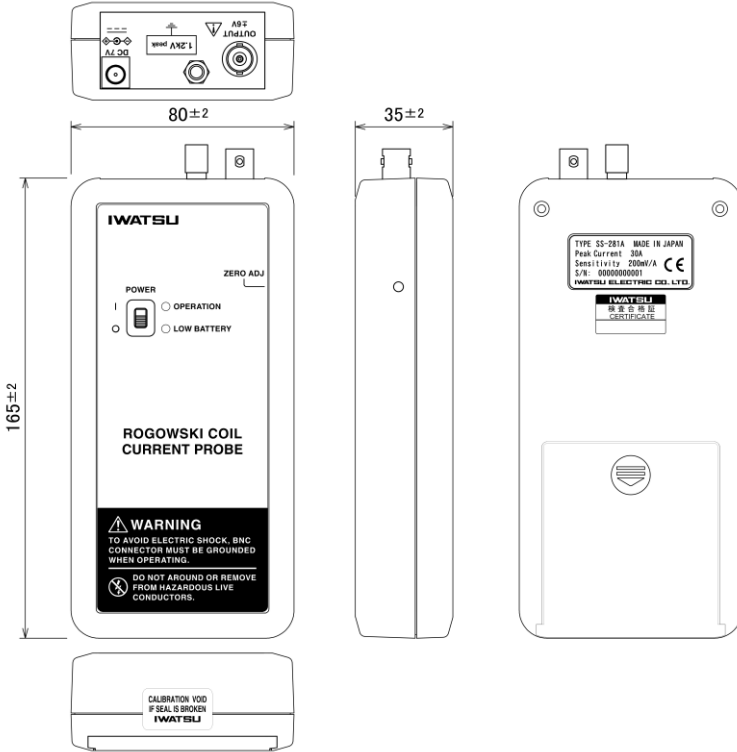

Unit: mm

(2) Rogowski Coil Sensor

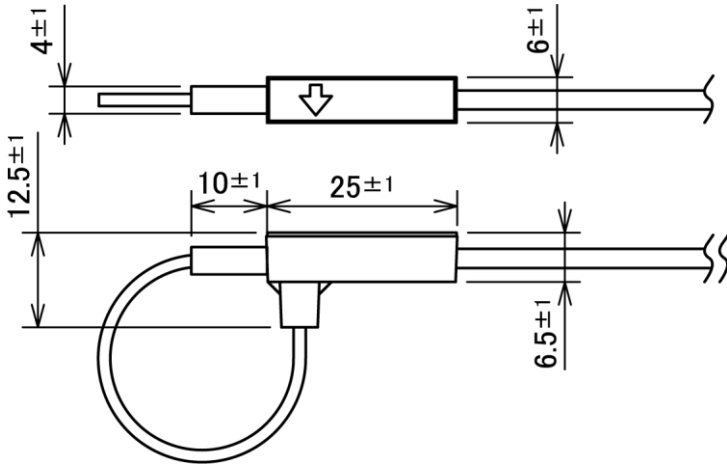

Unit: mm

IWATSU ELECTRIC CO., LTD.

Contact Us

Overseas Sales Sect. Sales Dept. No.2,

Address : 7-41, Kugayama 1-Chome, Suginami-ku, Tokyo, 168-8501
Japan

Phone : +81 3 5370 5483

Facsimile : +81 3 5370 5492

URL : http://www.iti.iwatsu.co.jp/index_e.html

E-mail : info-tme@iwatsu.co.jp

SS-281A(-H)/282A(-H)/283A(-H)/284A(-H)/285A(-H)
SS-286A(-H)/287A(-H)/288A(-H)/289A(-H)

IWATSU
